

# Single Crystal Diffraction

Arthur J. Schultz

Argonne National Laboratory

*National School on Neutron and X-Ray Scattering*

*June 13, 2011*

# What is a crystal?

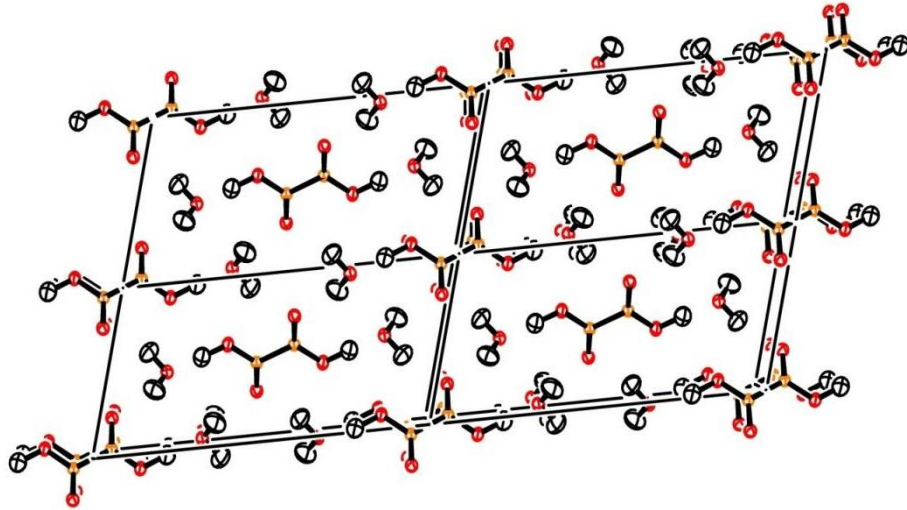

Unit cells of oxalic acid dihydrate

- Atoms (molecules) pack together in a regular pattern to form a crystal.
- Periodicity: we superimpose (mentally) on the crystal structure a repeating lattice or unit cell.
- A lattice is a regular array of geometrical points each of which has the same environment.



Quartz crystals

# Why don't the X-rays scatter in all directions?

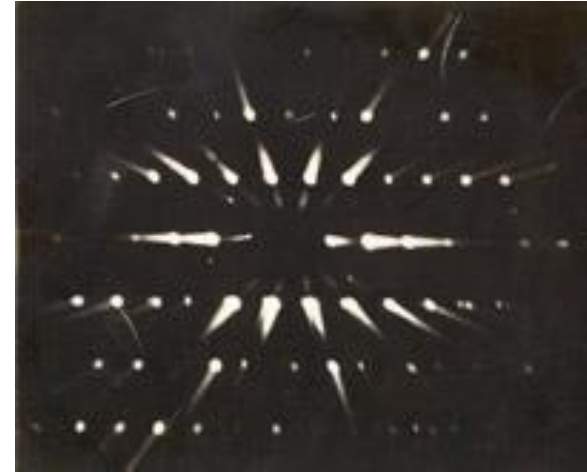

X-ray precession photograph  
(Georgia Tech, 1978).

- X-rays and neutrons have wave properties.
- A crystal acts as a diffraction grating producing constructive and destructive interference.

# Bragg's Law

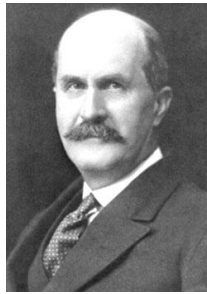

William Henry Bragg



William Lawrence Bragg

Jointly awarded the 1915  
Nobel Prize in Physics

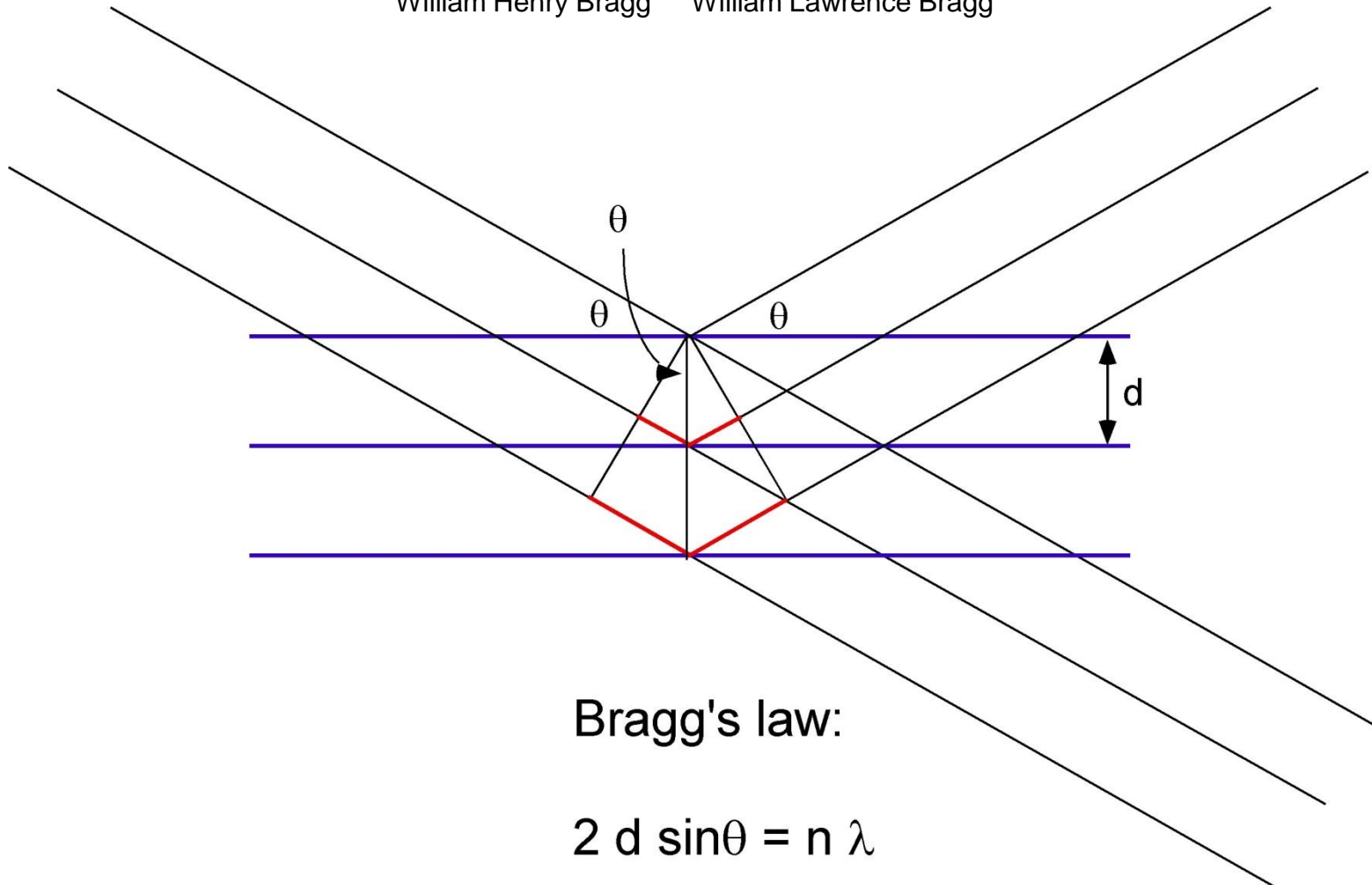

Bragg's law:

$$2 d \sin \theta = n \lambda$$

# Crystallographic Planes and Miller Indices

The  $(hkl)$  plane intercepts  $a/h$ ,  $b/k$ ,  $c/l$  on crystallographic axes  $X, Y, Z$ , where  $h, k, l$  are relatively prime integers.

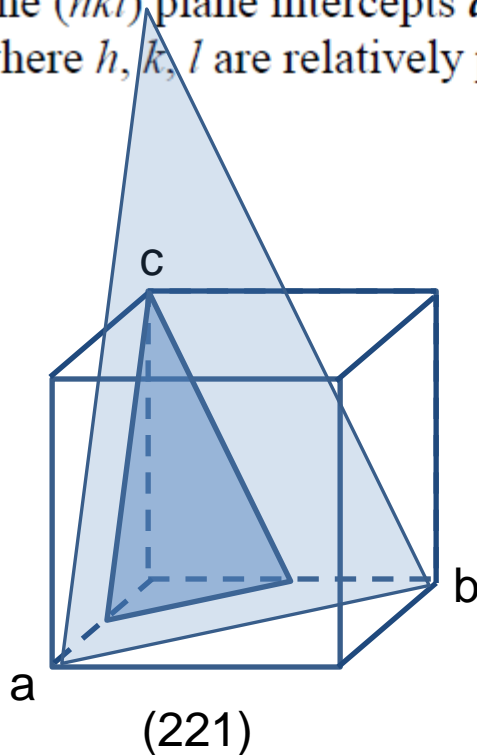

Intercepts	$\frac{a}{h}, \frac{b}{k}, \frac{c}{l}$
Fractional intercepts	$\frac{1}{h}, \frac{1}{k}, \frac{1}{l}$
Reciprocals of the fractional intercepts	$h, k, l$
Miller Indices ( <i>prime integers</i> )	$h, k, l$

$d$ -spacing = spacing between origin and first plane or between neighboring planes in the family of planes.

# Laue Equations



Max von Laue  
1914 Noble Prize for Physics

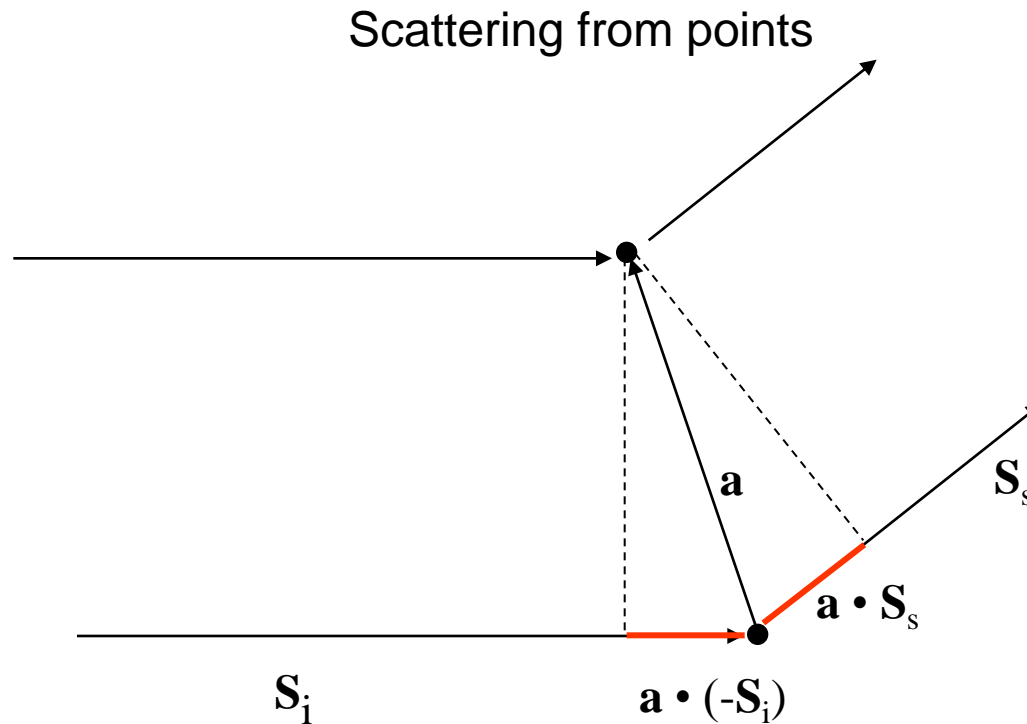

$$\mathbf{a} \cdot \mathbf{S}_s + \mathbf{a} \cdot (-\mathbf{S}_i) = \mathbf{a} \cdot (\mathbf{S}_s - \mathbf{S}_i) = h\lambda$$

In three dimensions  $\rightarrow$

$$\mathbf{a} \cdot (\mathbf{S}_s - \mathbf{S}_i) = h\lambda$$

$$\mathbf{b} \cdot (\mathbf{S}_s - \mathbf{S}_i) = k\lambda$$

$$\mathbf{c} \cdot (\mathbf{S}_s - \mathbf{S}_i) = l\lambda$$

# Real and reciprocal Space

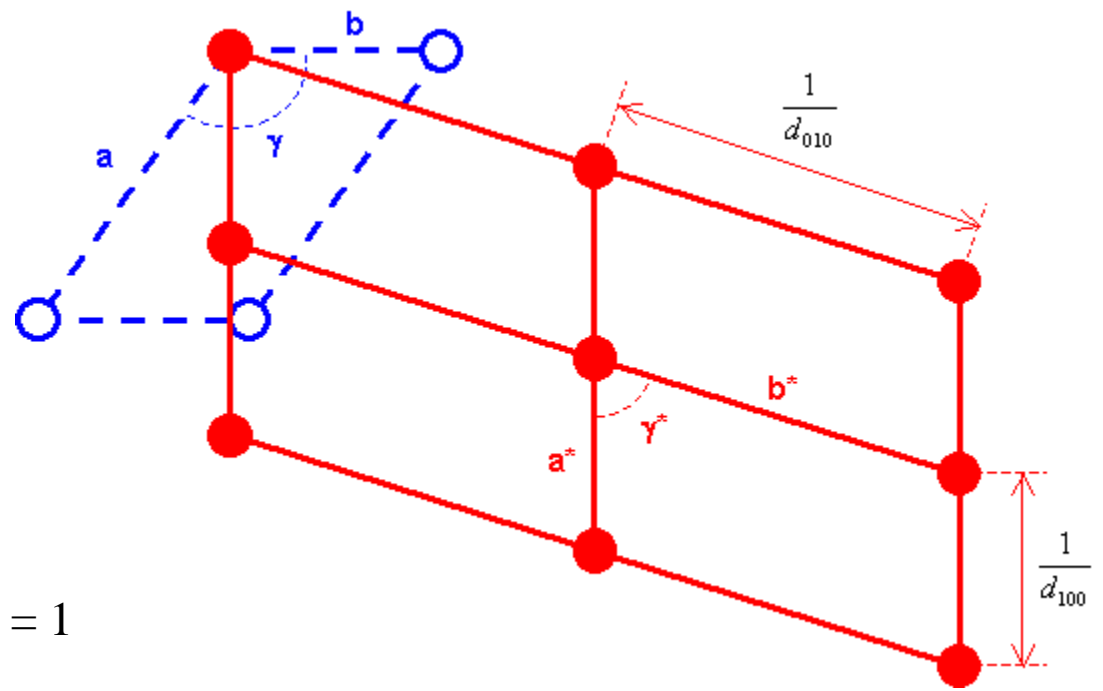
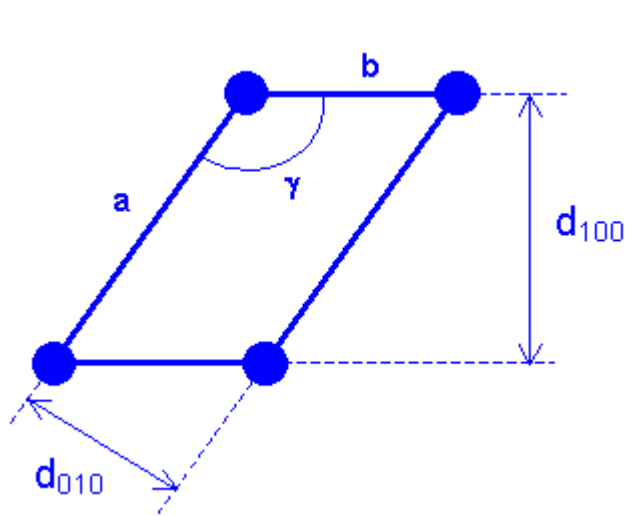

$$\mathbf{a}^* \cdot \mathbf{a} = \mathbf{b}^* \cdot \mathbf{b} = \mathbf{c}^* \cdot \mathbf{c} = 1$$

$$\mathbf{a}^* \cdot \mathbf{b} = \dots = 0$$

Laue equations:

$$\mathbf{a} \cdot (\mathbf{S}_s - \mathbf{S}_i) = h\lambda, \text{ or } \mathbf{a} \cdot \mathbf{s} = h$$

$$\mathbf{b} \cdot (\mathbf{S}_s - \mathbf{S}_i) = k\lambda, \text{ or } \mathbf{b} \cdot \mathbf{s} = k$$

$$\mathbf{c} \cdot (\mathbf{S}_s - \mathbf{S}_i) = l\lambda, \text{ or } \mathbf{c} \cdot \mathbf{s} = l$$

where

$$\mathbf{s} = (\mathbf{S}_s - \mathbf{S}_i)/\lambda = h\mathbf{a}^* + k\mathbf{b}^* + l\mathbf{c}^*$$

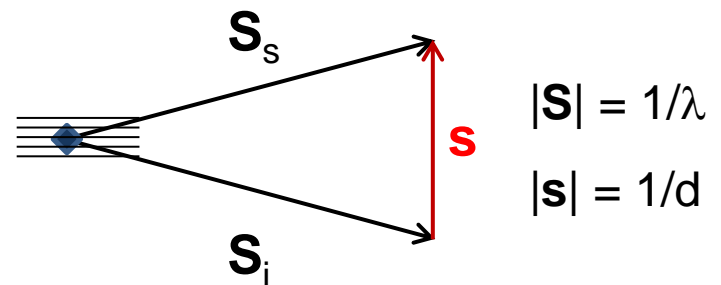

# The Ewald Sphere

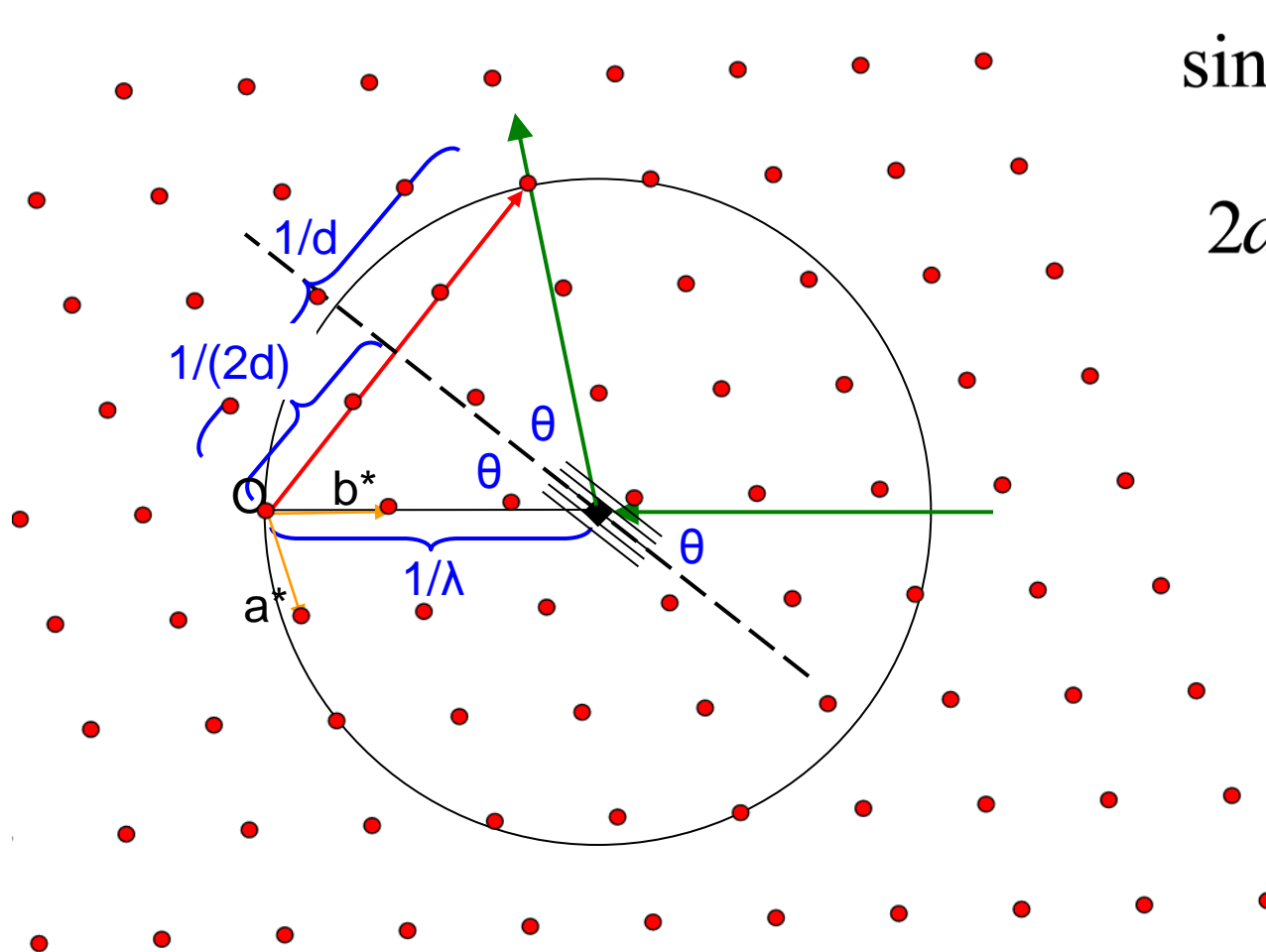

$$\sin(\theta) = \frac{1/(2d)}{1/\lambda}$$

$$2d \sin(\theta) = \lambda$$



# The Ewald sphere: the movie

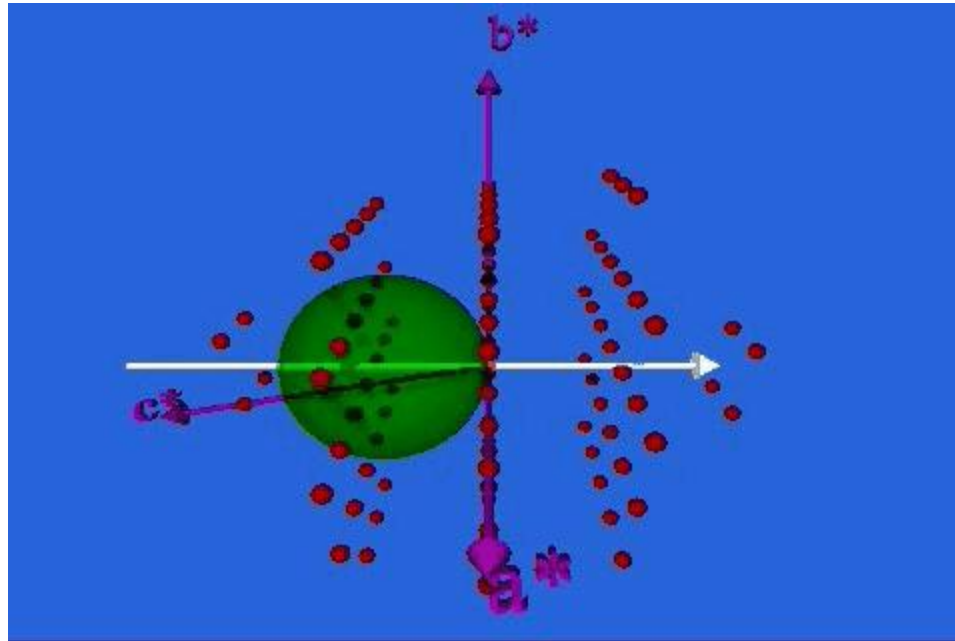

Courtesy of the CSIC (Spanish National Research Council).  
<http://www.xtal.iqfr.csic.es/Cristalografia/index-en.html>

# Bragg Peak Intensity

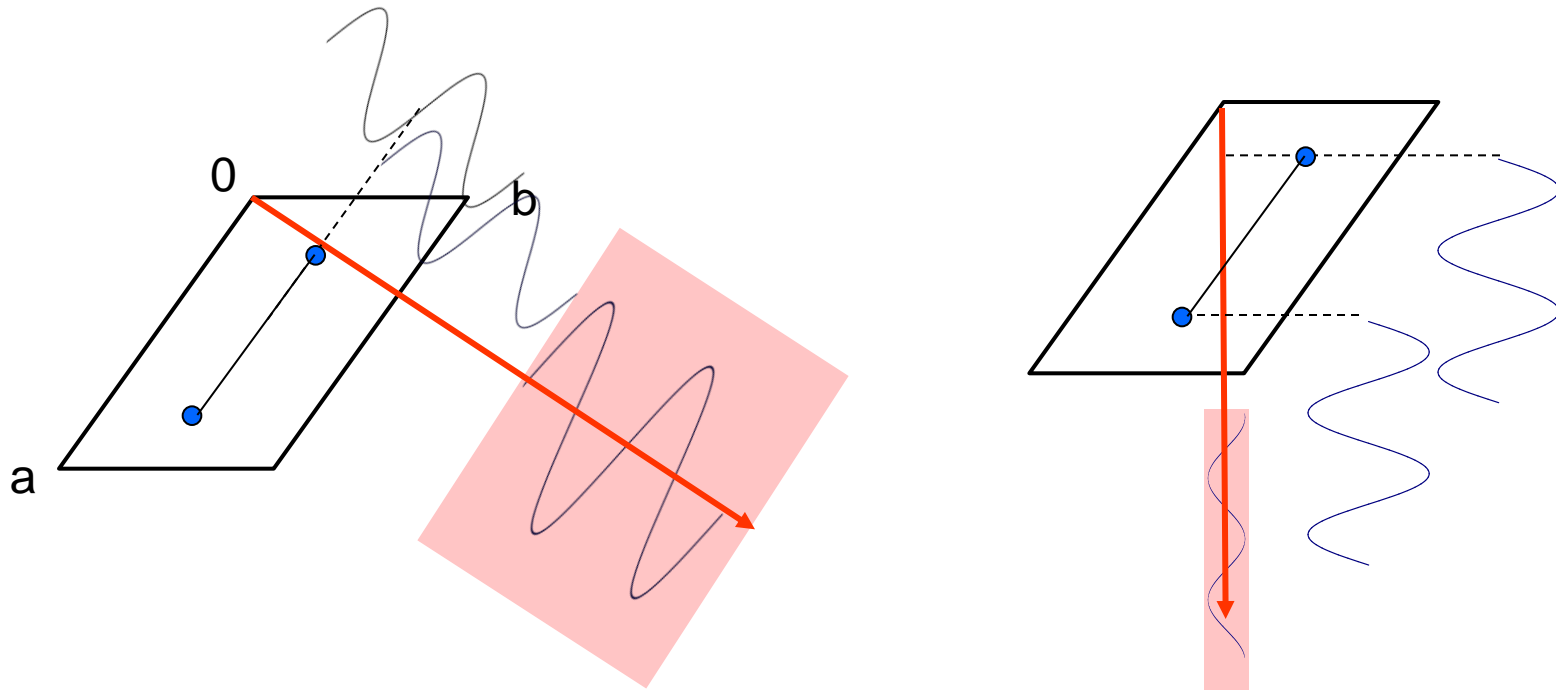

Relative phase shifts  
related to molecular  
structure.

$$F_{hkl} = \sum_i b_i \exp(2\pi i \mathbf{s} \cdot \mathbf{r})$$

$$F_{hkl} = \sum_i b_i \exp[2\pi i (hx + ky + lz)]$$

$$F_{hkl}^2 \approx I_{hkl}$$

# $\theta$ - $2\theta$ Step Scan

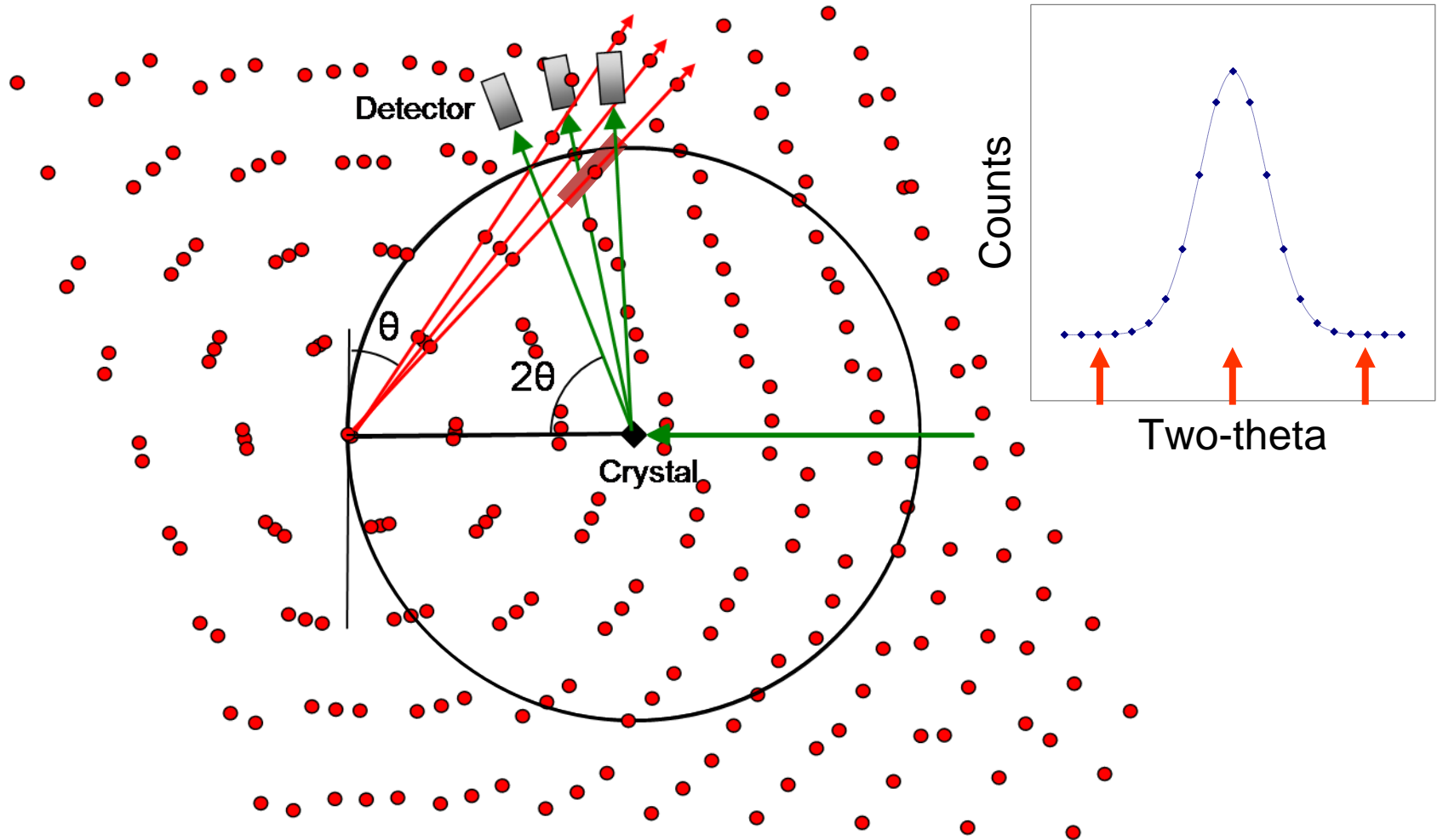

# Omega Step Scan

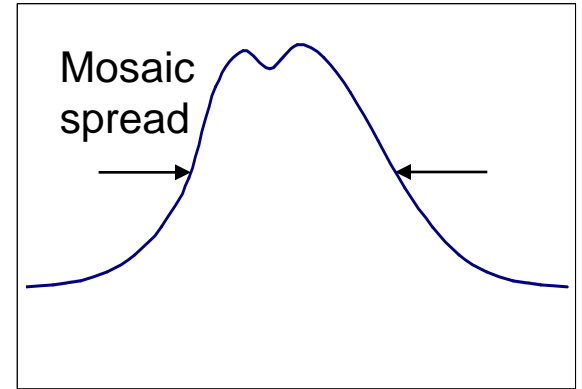
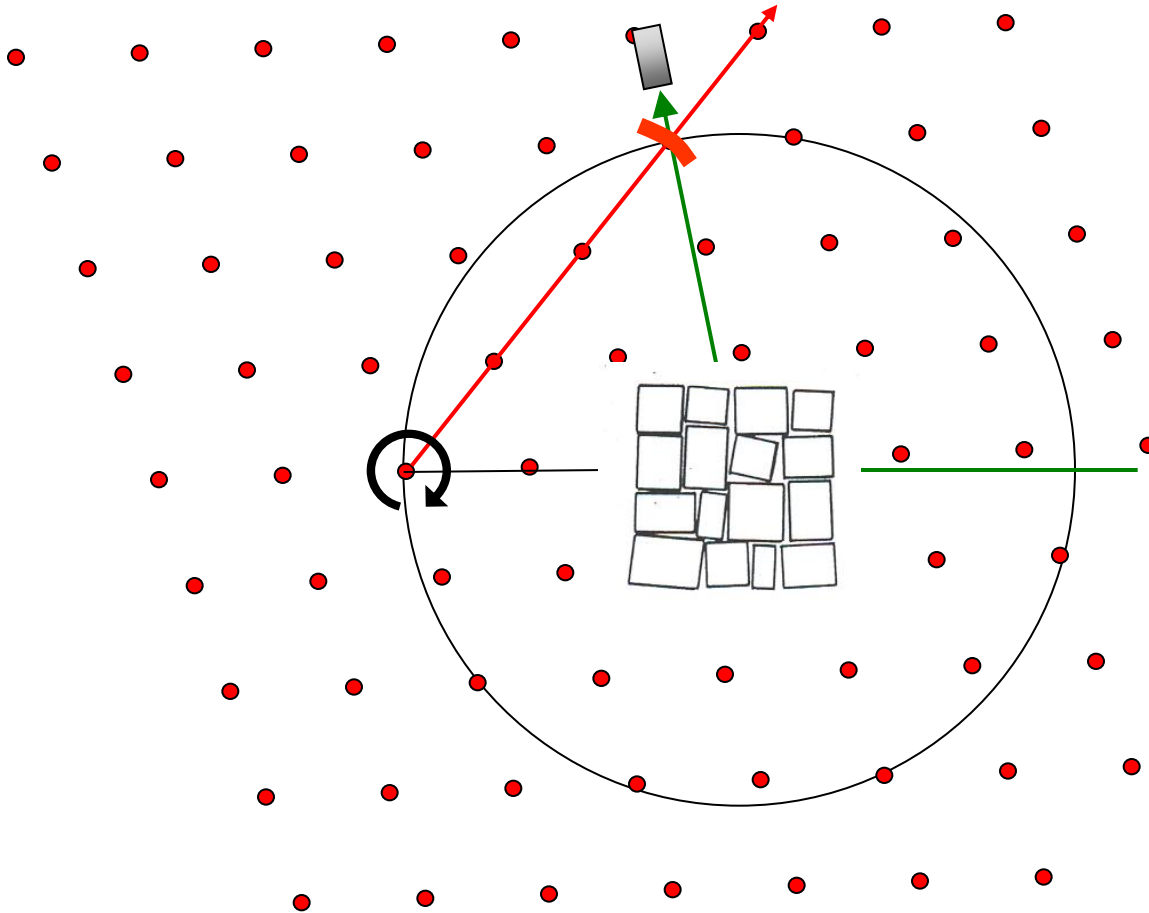

Omega

1. Detector stationary at  $2\theta$  angle.
2. Crystal is rotated about  $\theta$  by  $\pm \omega$ .
3. FWHM is the mosaic spread.

# ***Something completely different - polycrystallography***

## ***What is a powder? - polycrystalline mass***

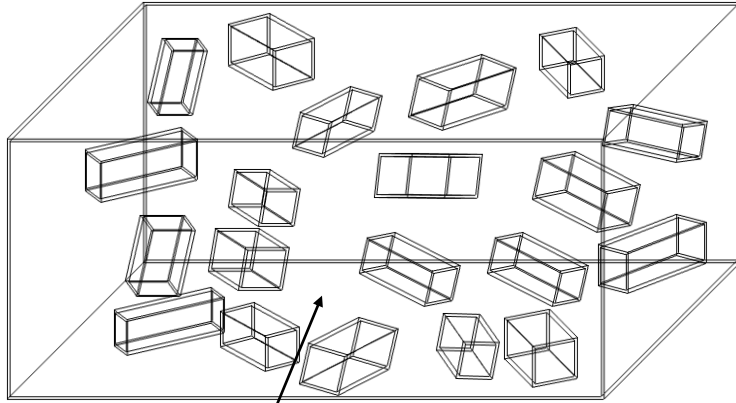

**All orientations of crystallites possible**

**Sample: 1  $\mu$ l powder of 1  $\mu$ m crystallites -  $\sim 10^9$  particles**

**Packing efficiency – typically 50%  
Spaces – air, solvent, etc.**

**Single crystal reciprocal lattice  
- smeared into spherical shells**

# Powder Diffraction

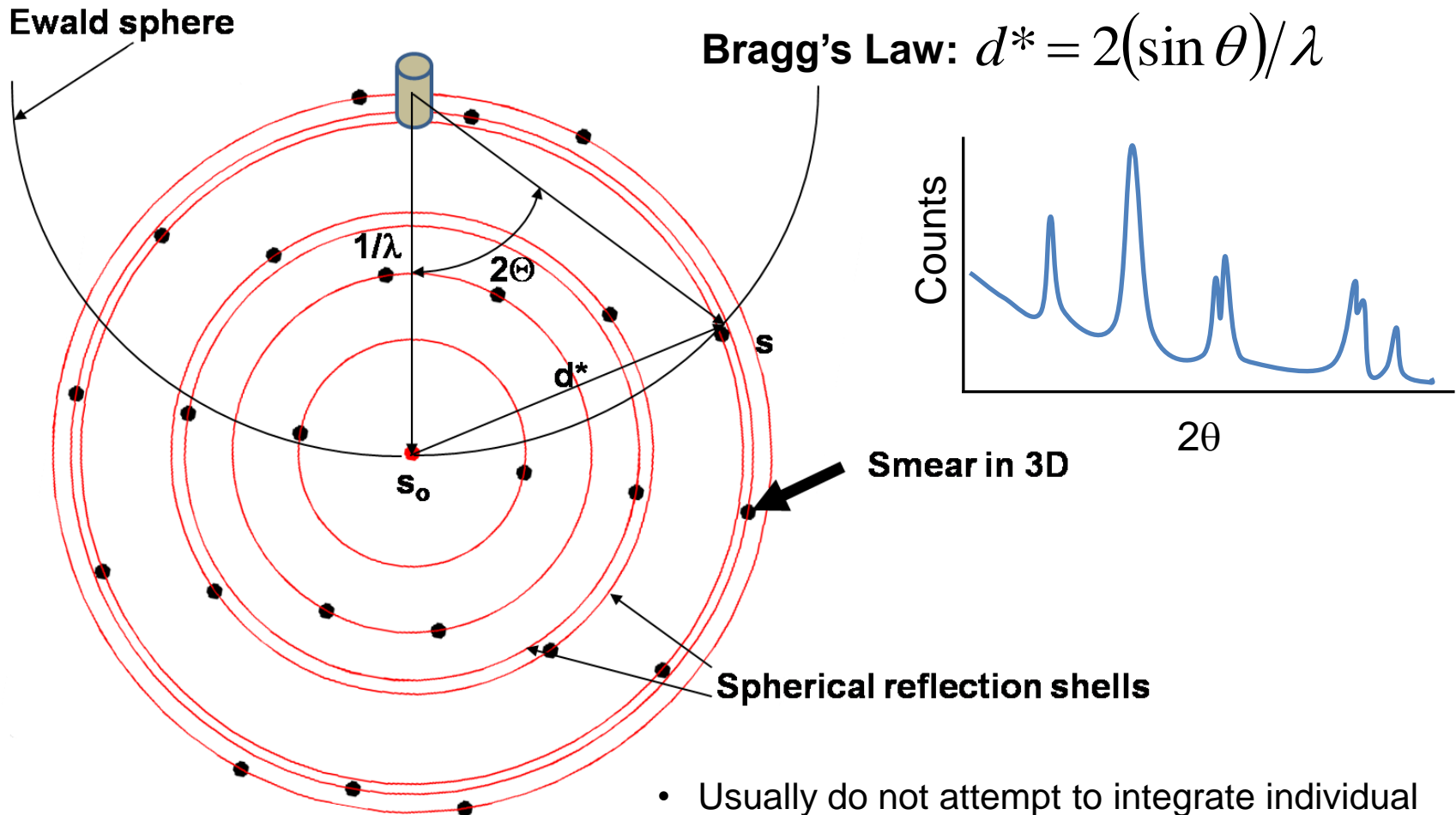

- Usually do not attempt to integrate individual peaks.
- Instead, fit the spectrum using Rietveld profile analysis. Requires functions that describe the peak shape and background.

# Why do single crystal diffraction (vs. powder diffraction)?

- Smaller samples – 1-10 mg vs 500-5000 mg
- Larger molecules and unit cells
- Hydrogen is ok – generally does not need to be deuterated
- Less absorption
- Fourier coefficients are more accurate – based on integrating well-resolved peaks
- Uniquely characterize non-standard scattering – superlattice and satellite peaks (commensurate and incommensurate), diffuse scattering (rods, planes, etc.)

## **But:**

- Need to grow a single crystal
- Data collection can be more time consuming

# Some history of single crystal neutron diffraction

THE JOURNAL OF CHEMICAL PHYSICS VOLUME 19, NUMBER 11 NOVEMBER, 1951

## The Use of Single-Crystal Neutron Diffraction Data for Crystal Structure Determination\*

S. W. PETERSON AND HENRI A. LEVY  
*Oak Ridge National Laboratory, Oak Ridge, Tennessee*  
(Received August 30, 1951)

Intensities of neutron reflections from single crystal specimens of several substances have yielded structure factors in close agreement with calculation and with those measured by the usual powder method. Specimens whose dimensions were in the millimeter range were used. Three materials yielded low results, probably because of extinction in the single crystal specimens. The use of single crystal neutron reflections for crystal structure determination appears practical in many cases.

THE JOURNAL OF CHEMICAL PHYSICS VOLUME 20, NUMBER 4 APRIL, 1952

## A Single Crystal Neutron Diffraction Determination of the Hydrogen Position in Potassium Bifluoride\*

S. W. PETERSON AND HENRI A. LEVY  
*Chemistry Division, Oak Ridge National Laboratory, Oak Ridge, Tennessee*  
(Received December 10, 1951)

Neutron diffraction measurements on  $\text{KHF}_2$  single crystals show that the hydrogen atom occupies the central position, within 0.1Å, in the linear F—H—F ion. The data also indicate asymmetry in thermal motion, which suggests that the bifluoride ion undergoes rotatory oscillation with appreciable amplitude. The study demonstrates the usefulness of single crystal neutron diffraction data for crystal structure determination.

- 1951 – Peterson and Levy demonstrate the feasibility of single crystal neutron diffraction using the Graphite Reactor at ORNL.
- 1950s and 1960s – Bill Busing, Henri Levy, Carroll Johnson and others wrote a suite of programs for single crystal diffraction including ORFLS and ORTEP.
- 1979 – Peterson and coworkers demonstrate the single crystal neutron time-of-flight Laue technique at Argonne's ZING-P' spallation neutron source.



# The Orientation Matrix

*Acta Cryst.* (1967). **22**, 457

## Angle Calculations for 3- and 4- Circle X-ray and Neutron Diffractometers\*

BY WILLIAM R. BUSING AND HENRI A. LEVY

*Chemistry Division, Oak Ridge National Laboratory, Oak Ridge, Tennessee 37830, U.S.A.*

(Received 13 June 1966)

Methods are derived for calculations useful in the operation of 3- and 4-circle X-ray or neutron single-crystal diffractometers. These include: (1) establishing the sample orientation from the cell parameters and the observed angles for two reflections, or from the observed angles for three reflections only, (2) calculating the angles for observing a given reflection either in a special setting or at a specified azimuthal angle, (3) obtaining the vectors needed for calculating absorption corrections, and (4) using observations of several reflections to refine cell and orientation parameters by the method of least squares.

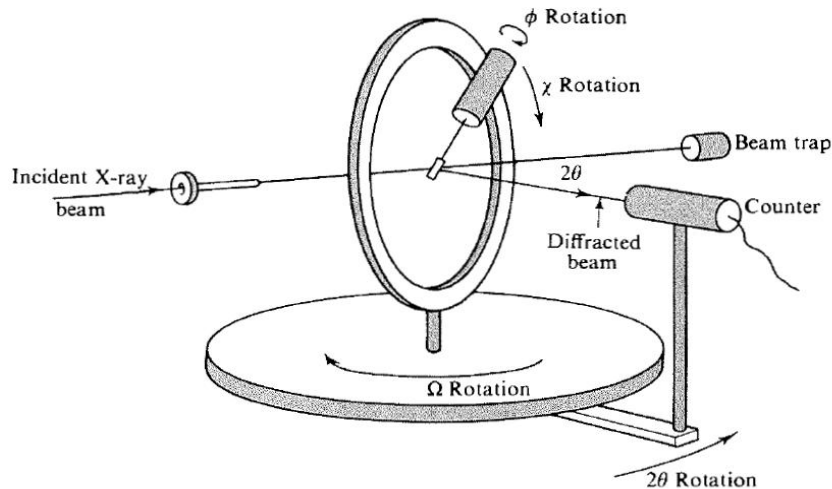

Fig. 5.29. A typical four-circle diffractometer. The counter rotates about the  $2\theta$  axis in one plane and the crystal may be orientated in any way by the three axes of rotation  $\phi$ ,  $\chi$  and  $\Omega$ .

$$\mathbf{B} = \begin{pmatrix} b_1 & b_2 \cos \beta_3 & b_3 \cos \beta_2 \\ 0 & b_2 \sin \beta_3 & -b_3 \sin \beta_2 \cos \alpha_1 \\ 0 & 0 & 1/a_3 \end{pmatrix}$$

$\mathbf{U}$  is a rotation matrix relating the unit cell to the instrument coordinate system.

The matrix product  $\mathbf{UB}$  is called the *orientation matrix*.

# Picker 4-Circle Diffractometer



# Kappa Diffractometer

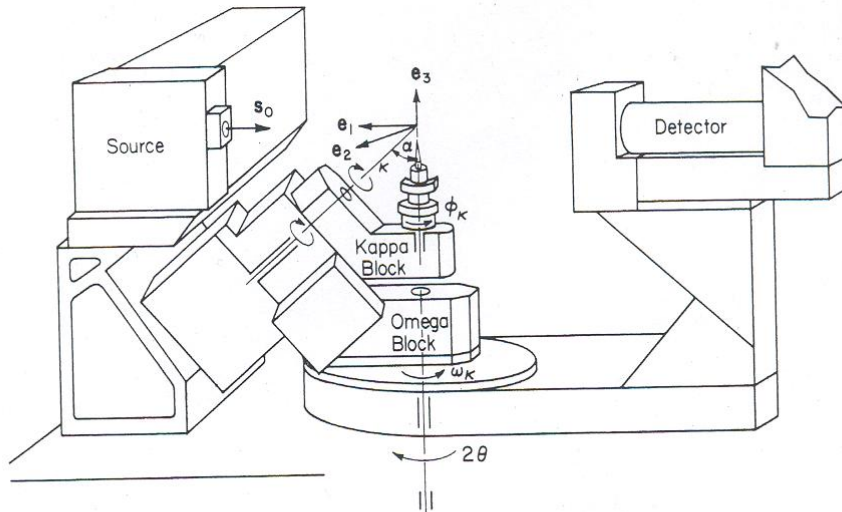

FIGURE 6-13. Kappa geometry. Adapted from operating manual for ENRAF-NONIUS CAD 4 diffractometer (angles  $\omega$ ,  $\phi$ , and  $\kappa$  are opposite in sign to those of Enraf-Nonius). (By permission of ENRAF-NONIUS Service Corp., Bohemia, New York.)



Brucker AXS: KAPPA APEX II

- Full 360° rotations about  $\omega$  and  $\phi$  axes.
- Rotation about  $\kappa$  axis reproduces quarter circle about  $\chi$  axis.

# Monochromatic diffractometer

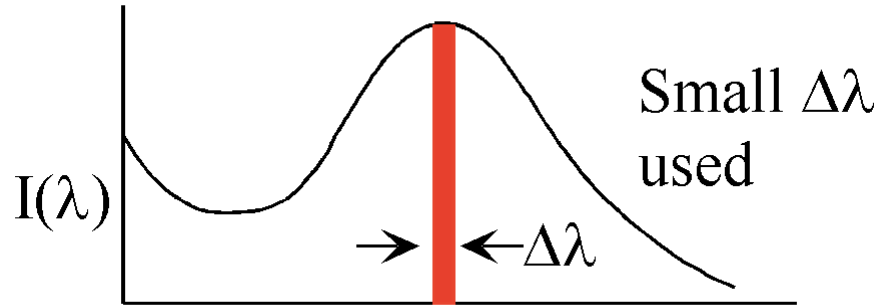

- Rotating crystal
- Vary  $\sin\theta$  in the Bragg equation:

$$2d \sin\theta = n\lambda$$

HFIR 4-Circle  
Diffractometer

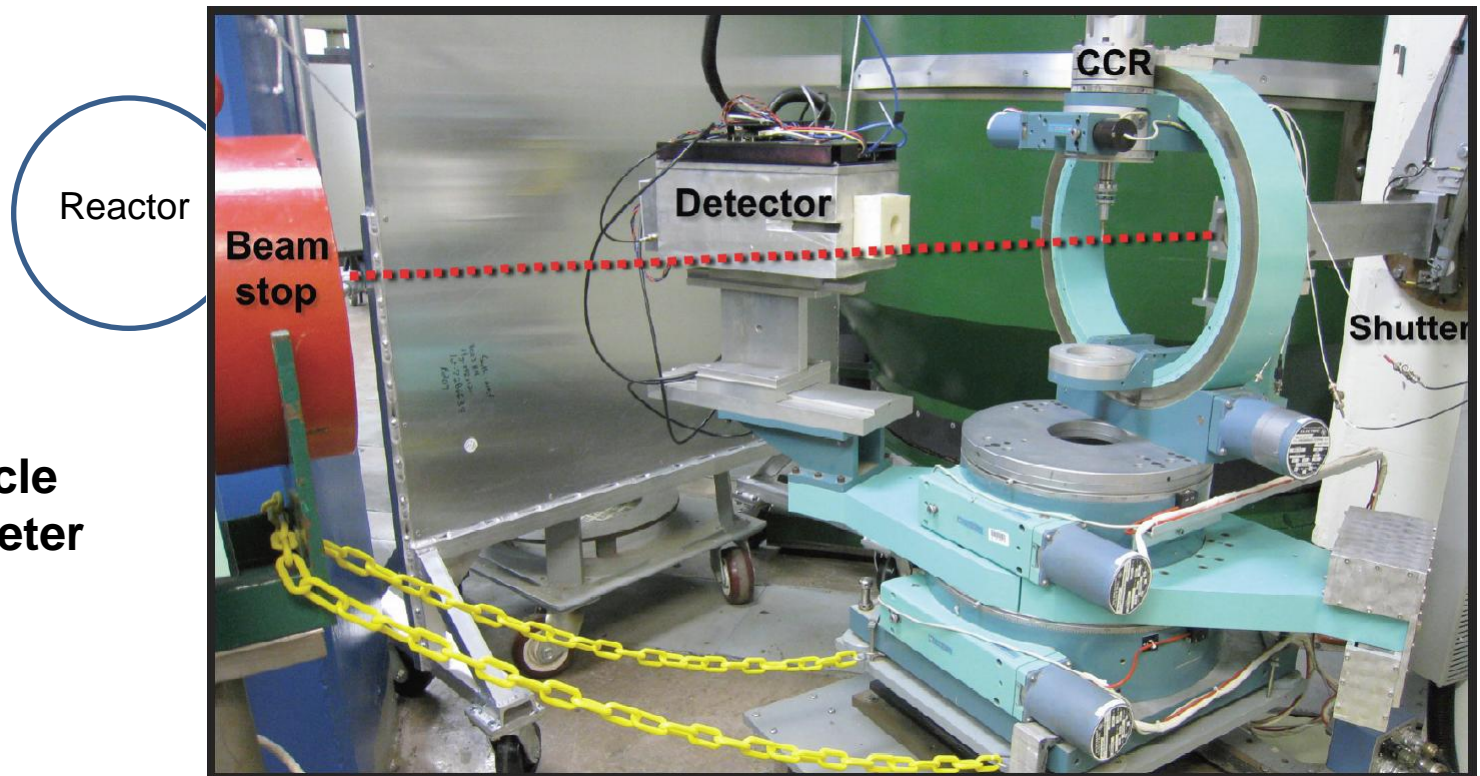

# Laue diffraction

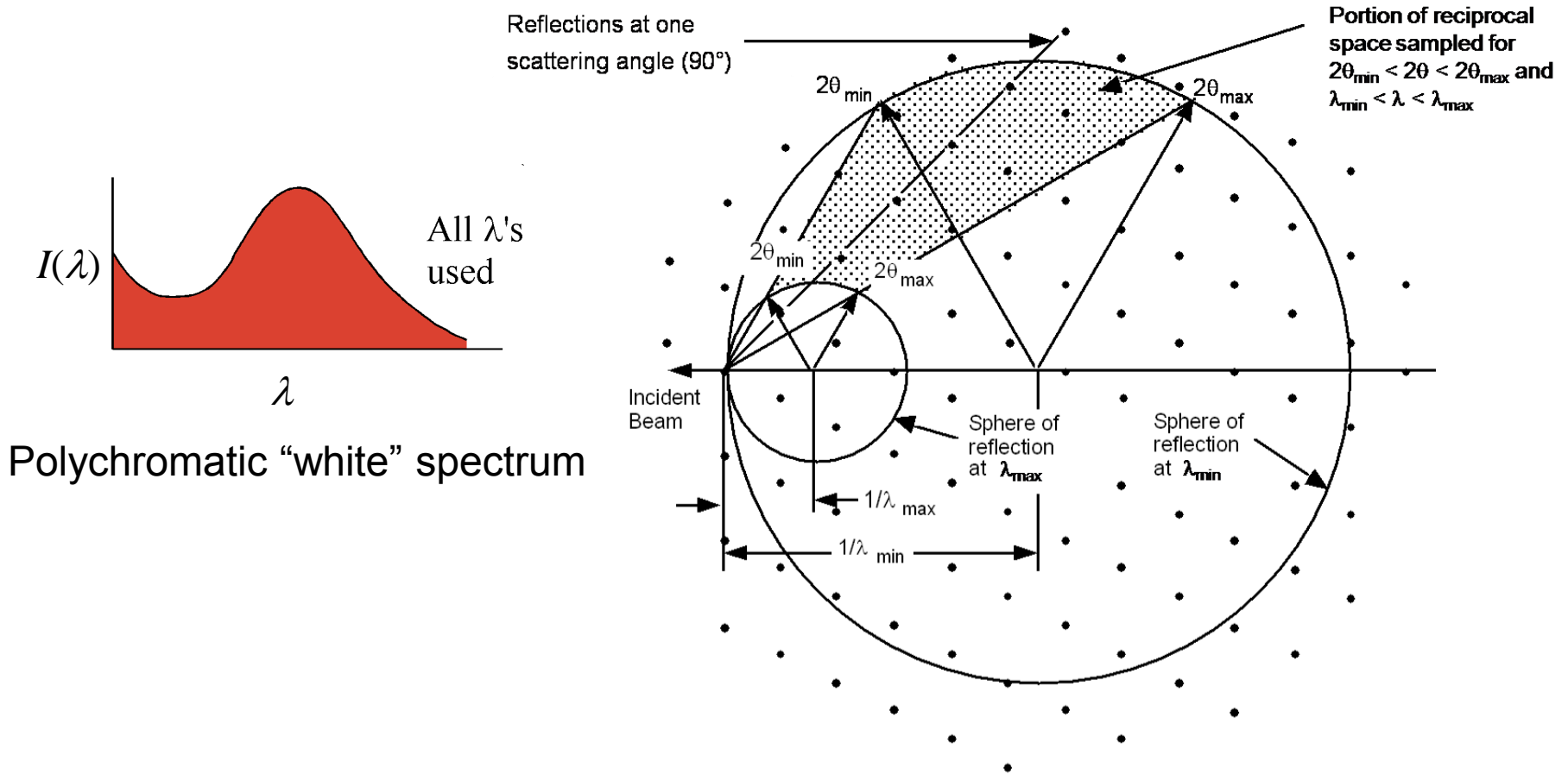

# Laue photo from white radiation

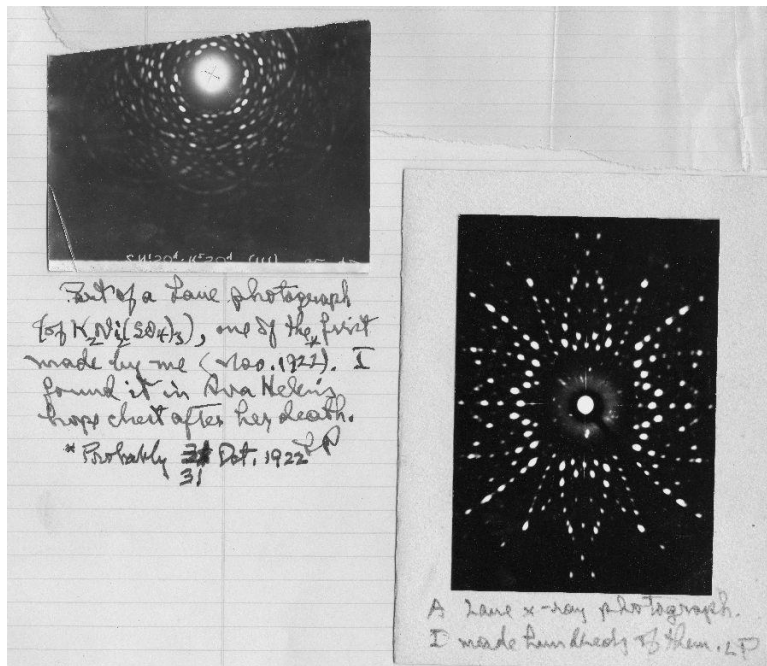

X-ray Laue photos taken  
by Linus Pauling

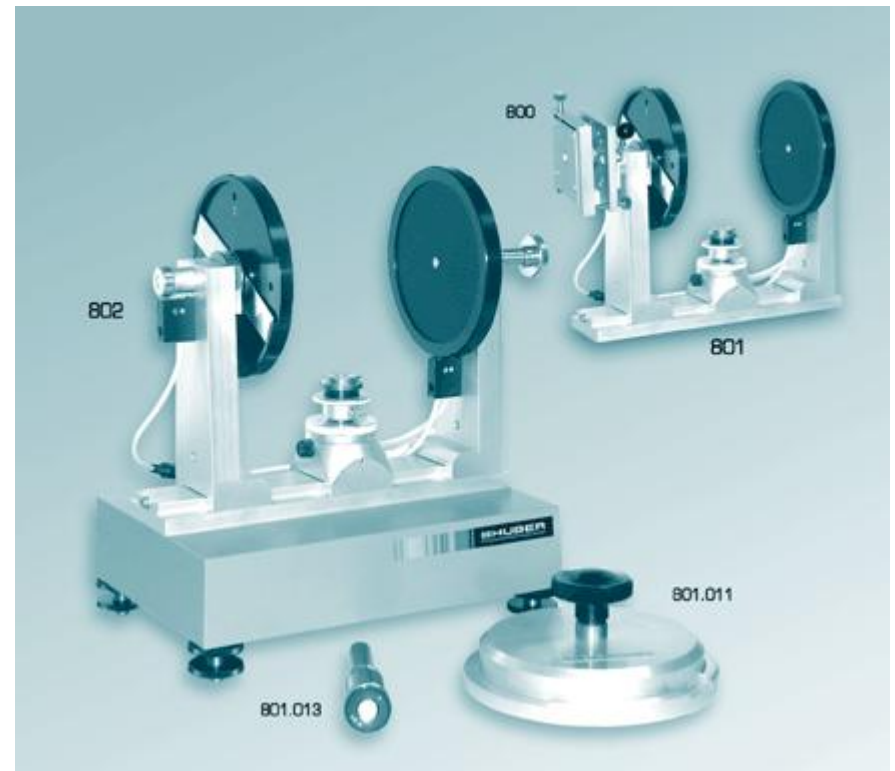

# Quasi-Laue Neutron Image Plate Diffractometer

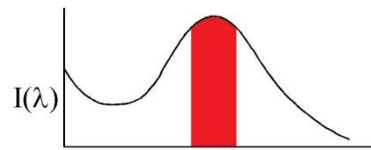

Select  $\Delta\lambda/\lambda$  of 10-20%

## 2012 at HFIR: IMAGINE



General view of the QLD

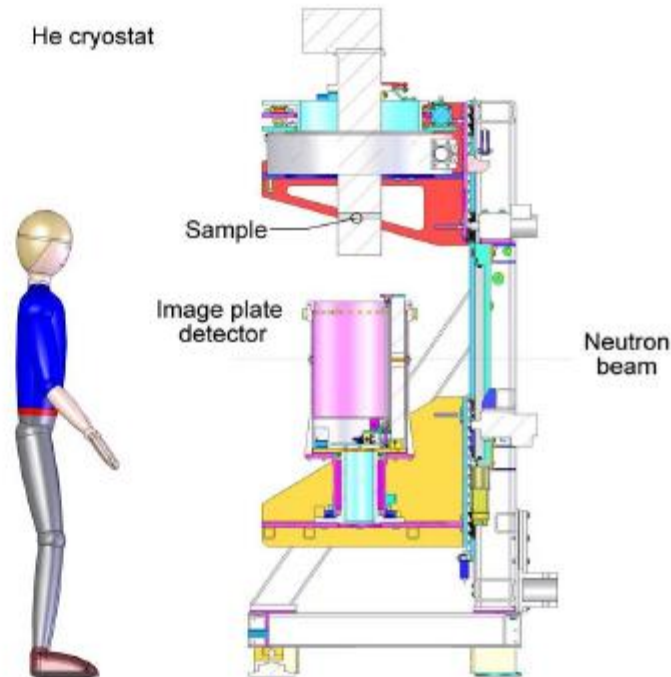

QLD schematic (open position)

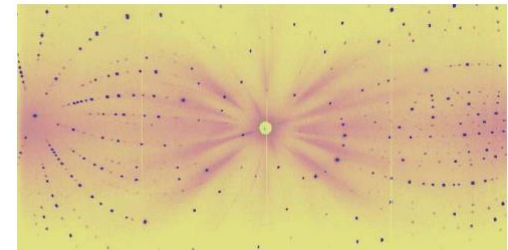

A typical Laue diffraction pattern from  $\text{FeTa}_2\text{O}_6$  just above the 3-D ferroelectric ordering temperature (Chung et al. *J. Phys.: Condens. Matter*, 16 (2004) 1-17). The faint cross of radial streaks about the central hole, which allows passage of the transmitted neutron beam, arises from 2-D magnetic ordering. Results from the Laue diffractometer VIVALDI at the ILL

# Pulsed Neutron Incident Spectrum

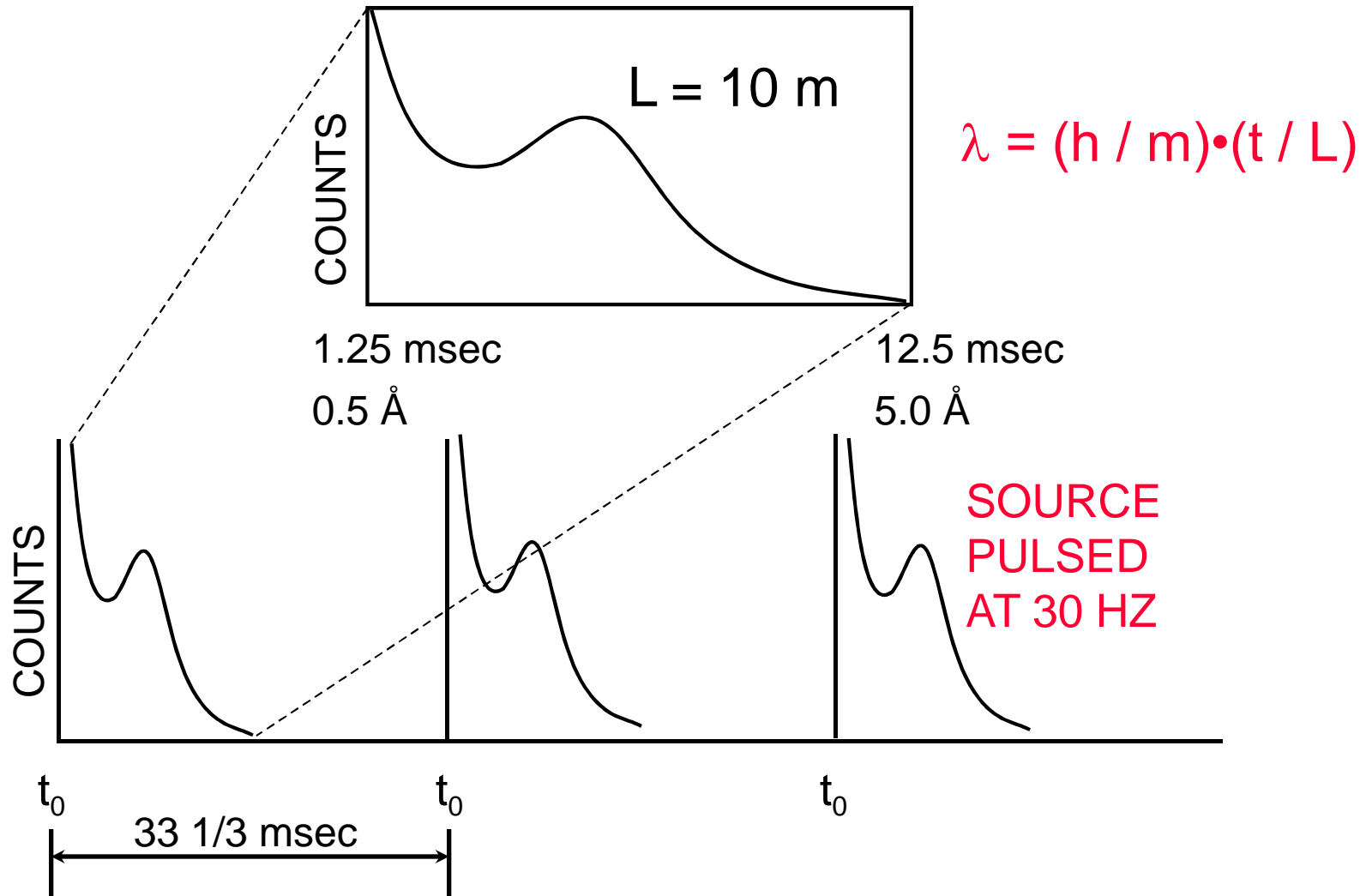



# Time-of-Flight Laue Technique

Reflections at one scattering angle ( $90^\circ$ ) resolved at different TOF's

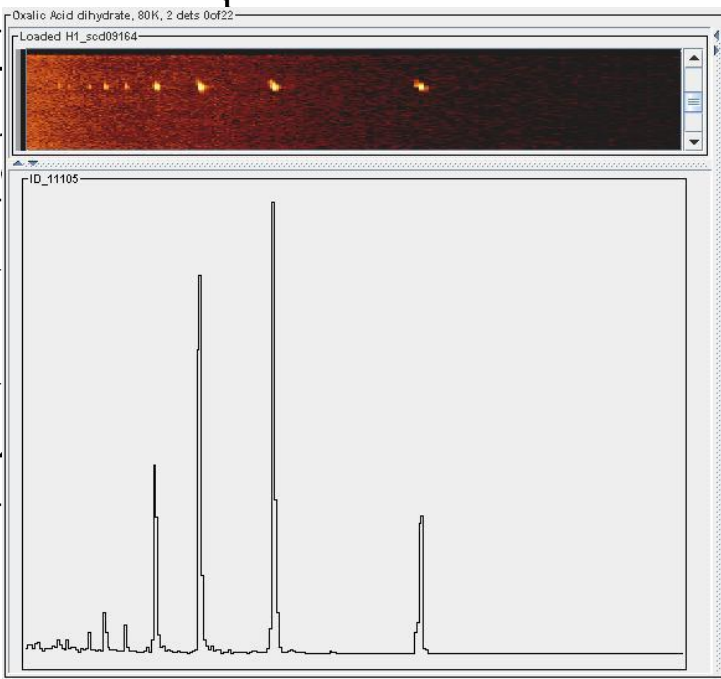
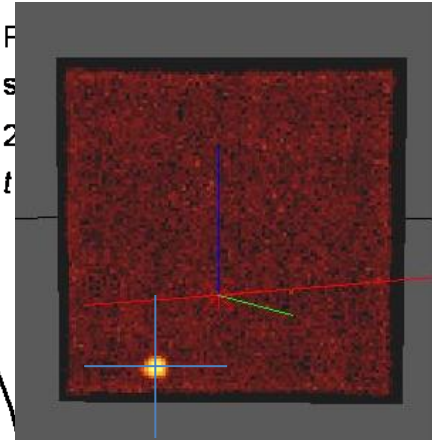
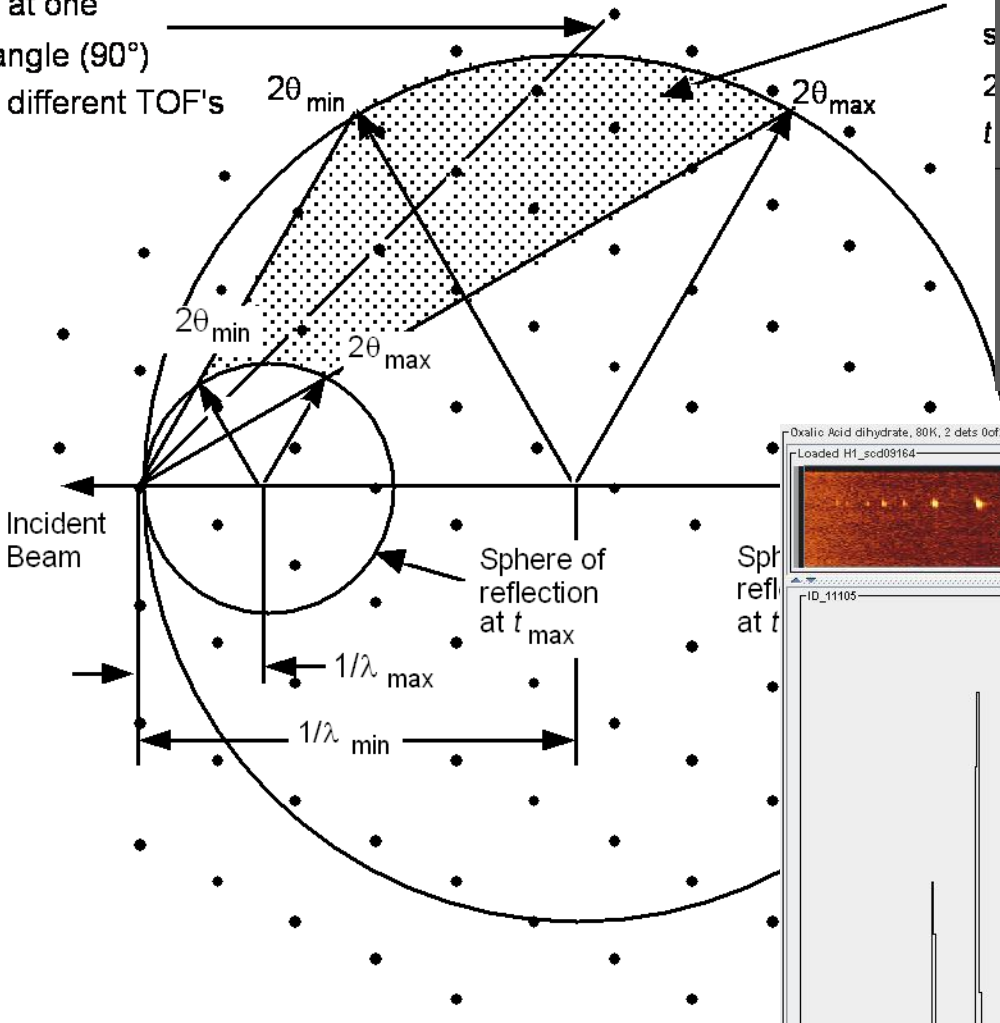

# SCD Instrument Parameters

Moderator	liq. methane at 105
Source frequency	30 Hz
Sample-to-moderator dist.	940 cm
Number of detectors	2
Detector active area	155 x 155 mm <sup>2</sup>
Scintillator	GS20 <sup>6</sup> Li glass
Scintillator thickness	2 mm
Efficiency @ 1 Å	0.86
Typical detector channels	100 x 100
Resolution	1.75 mm
Detector 1:	
angle	75°
sample-to-detector dist.	23 cm
Detector 2:	
angle	120°
sample-to-detector dist.	18 cm
Typical TOF range	1–25 ms
wavelength range	0.4–10 Å
<i>d</i> -spacing range	~0.3–8 Å
TOF resolution, $\Delta t/t$	0.01

## Sample Environments

Hot-Stage Displex: 4-900 K  
 Displex Closed Cycle Helium Refrigerator:  
 12–473 K  
 Furnaces: 300–1000 K  
 Helium Pressure Cell Mounted on Displex:  
 0–5 kbar @ 4–300 K

Detector distances on locus of constant solid angle in reciprocal space.

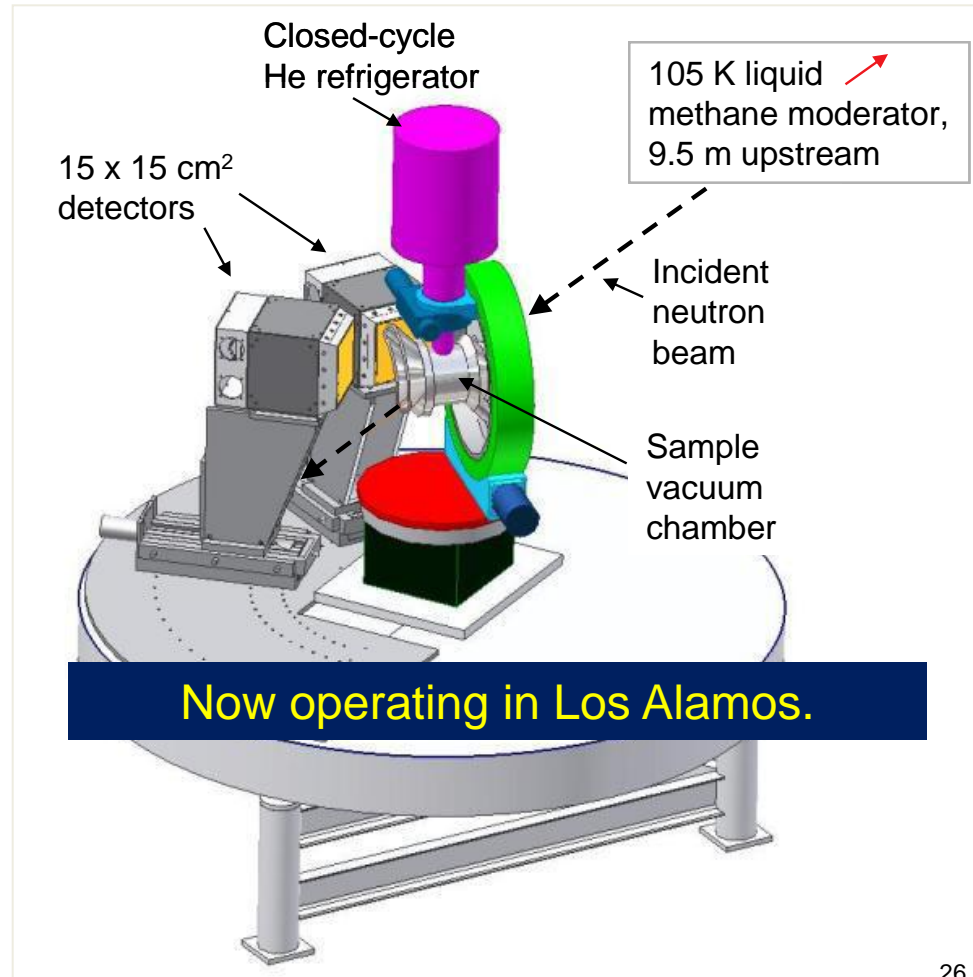

# ISAW hkl plot

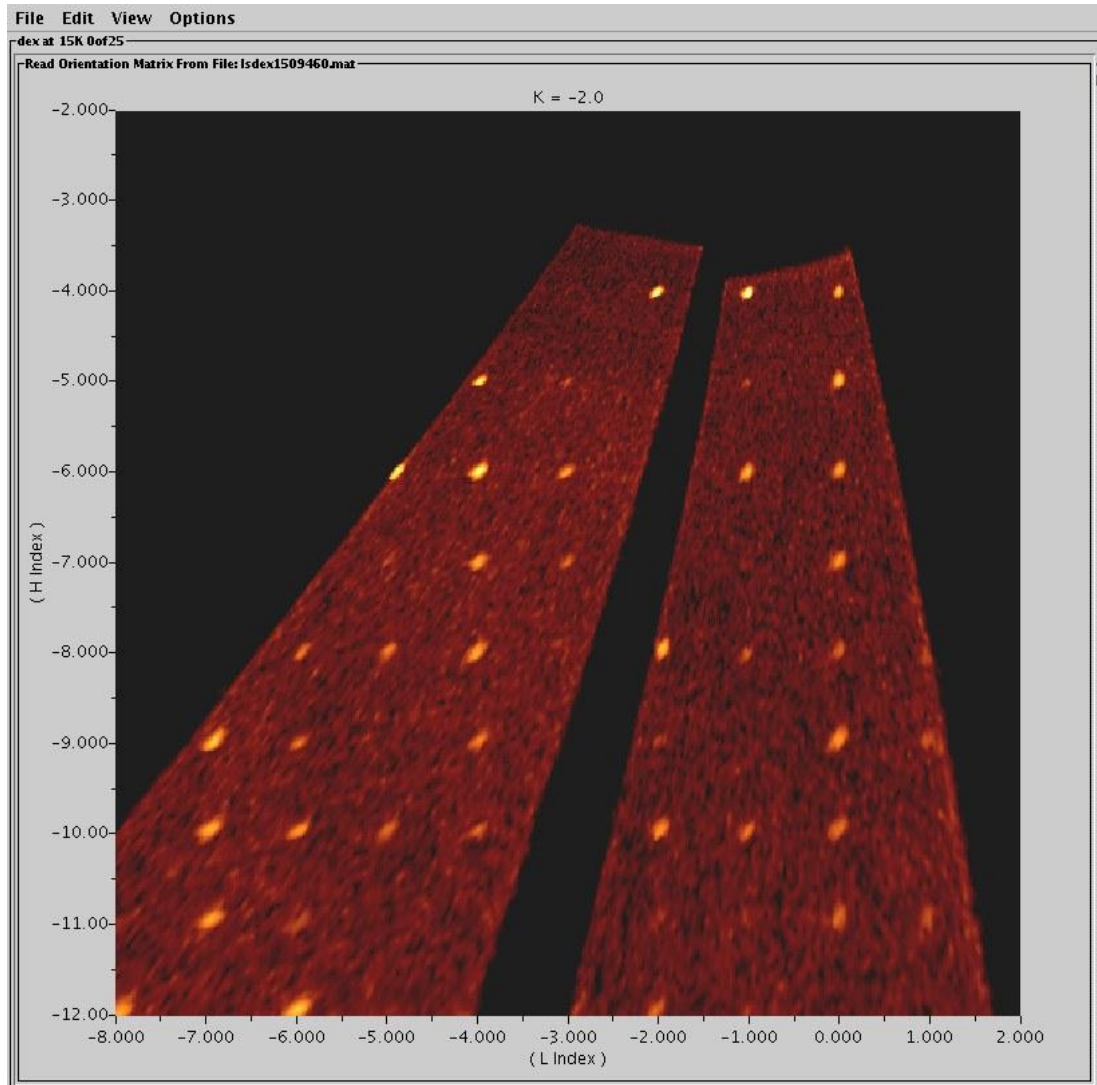

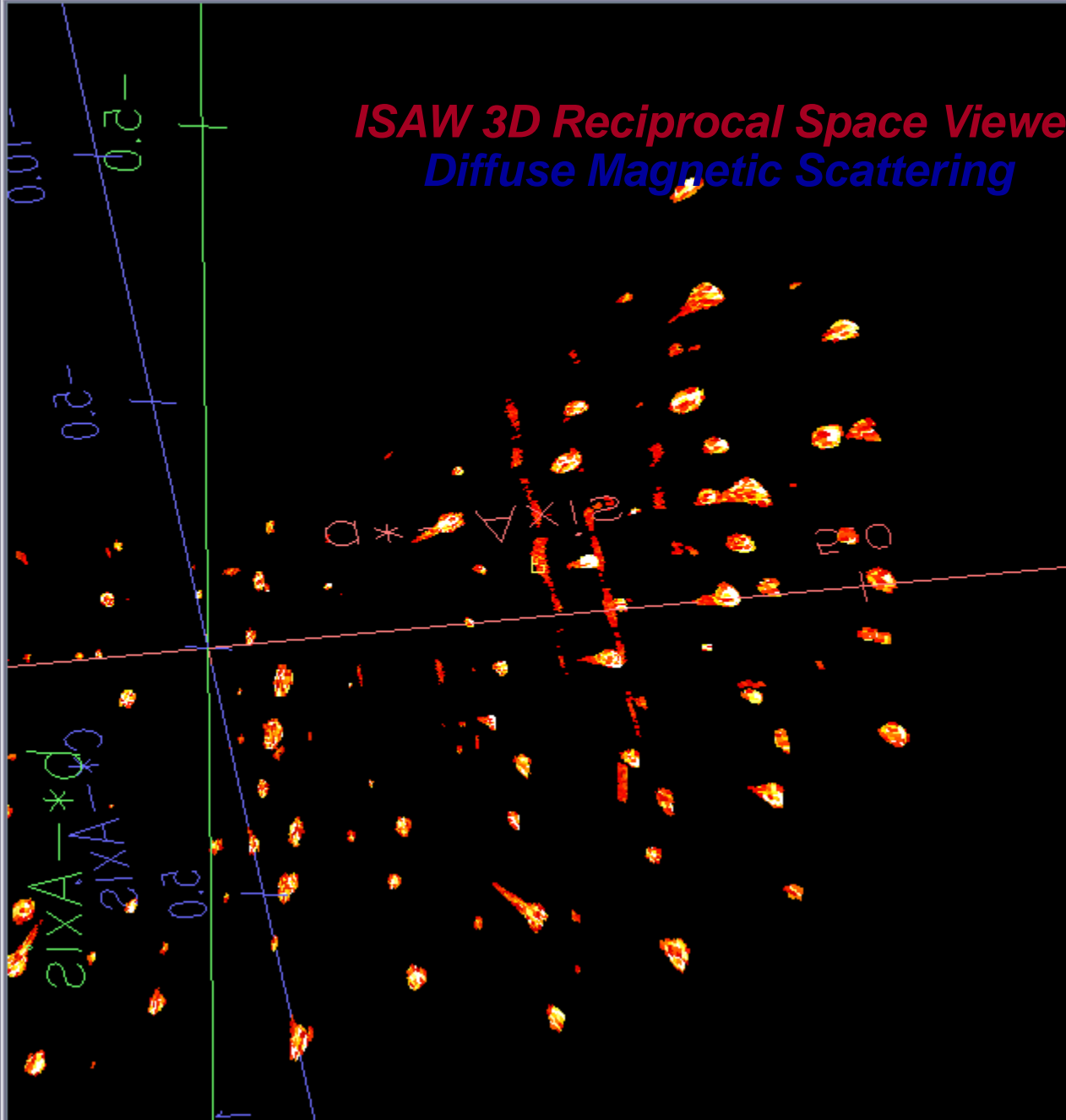

**ISAW 3D Reciprocal Space Viewer**  
**Diffuse Magnetic Scattering**

View Control

Altitude  $\angle$  -40.0°

Azimuth  $\angle$  -95.0°

Distance 12.8

Projection

Orthographic

View Planes

Qxyz

2.761, 0.057, 1.164

origin

Q : 2.761, 0.057, 1.164

|Q|: 2... Sel... Reset

(+)

Q : undefined

|Q|: undefined Select+

(\*)

Q : undefined

|Q|: undefined Select\*

Constant h Planes

Normal:

d [0]  $\sigma$ :

User-> FFT-> Filter... h [0]

Constant k Planes

Normal:

d [0]  $\sigma$ :

User-> FFT-> Filter... k [0]

Constant l Planes

Normal:

d [0]  $\sigma$ :

User-> FFT-> Filter... l [0]

Write Orientation Matrix

# SNAP

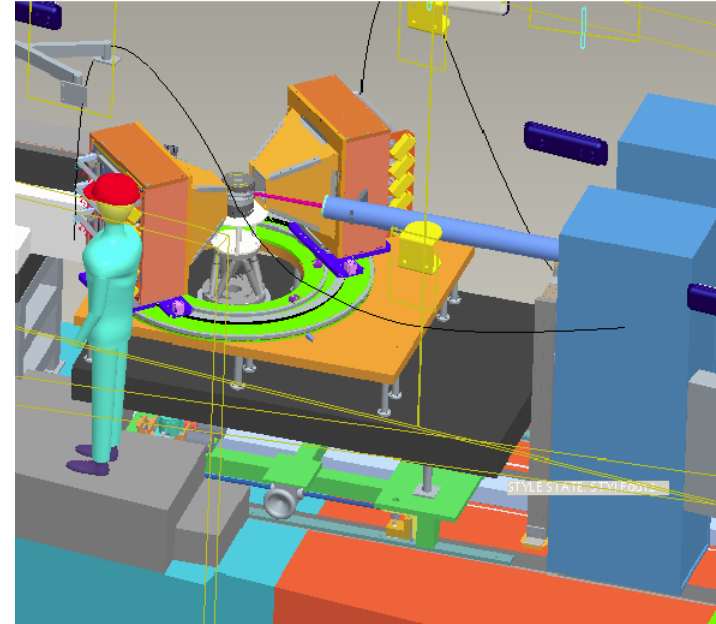

ORTEP of oxalic acid dihydrate from data measured on SNAP in December, 2008.

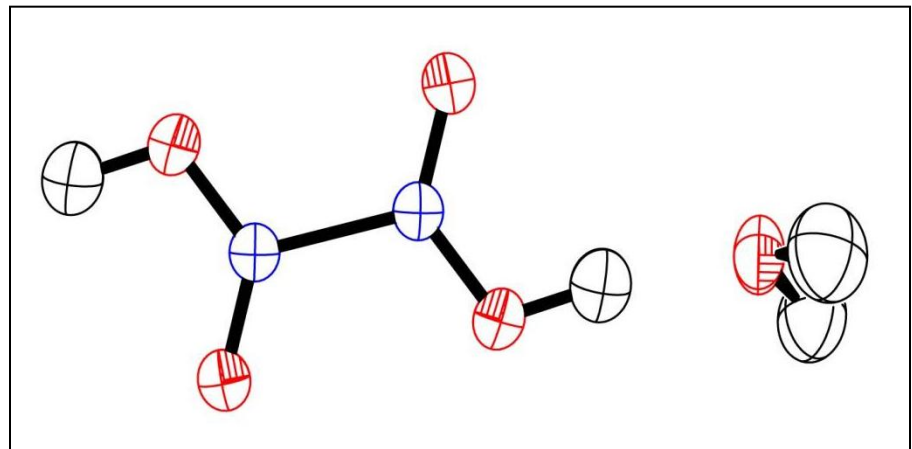

# Topaz

- Project Execution Plan requires a minimum of 2 steradian (approx. 23 detectors) coverage.
- Each detector active area is 150 mm x 150 mm.
- Secondary flight path varies from 400 mm to 450 mm radius and thus cover from 0.148 to 0.111 steradian each.

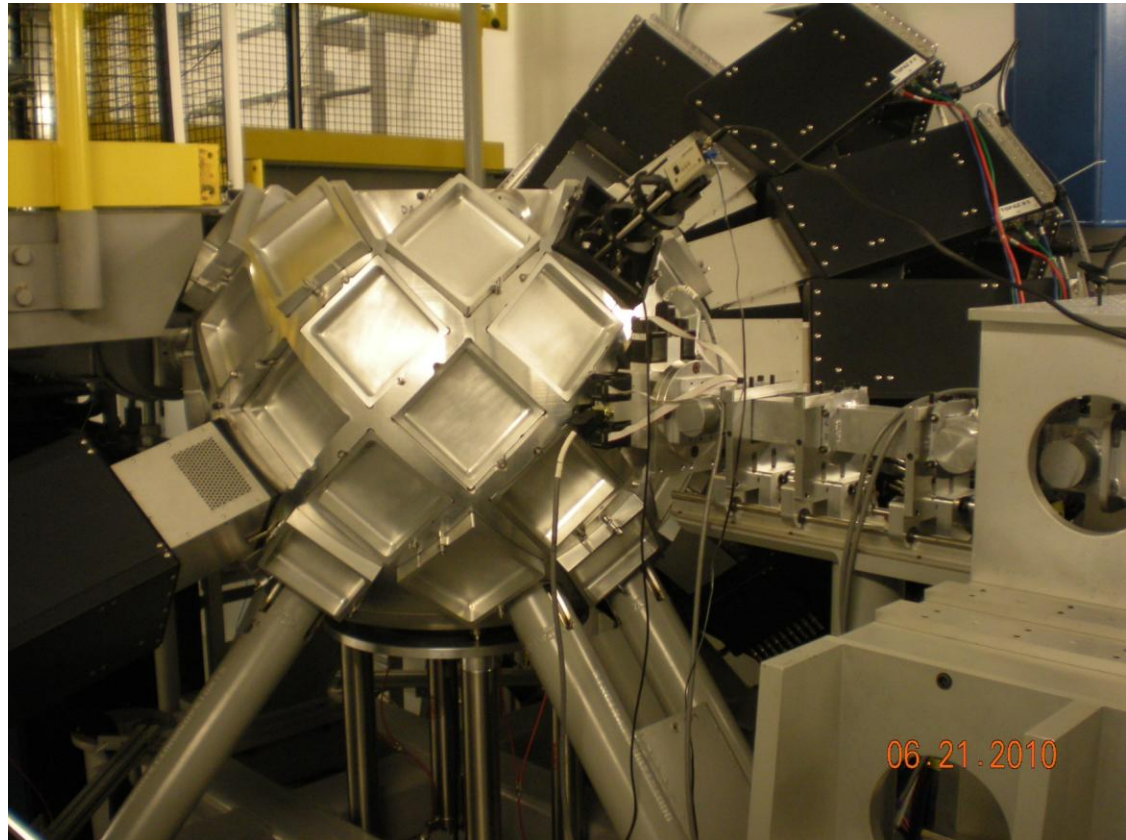

# Natrolite structure from TOPAZ data

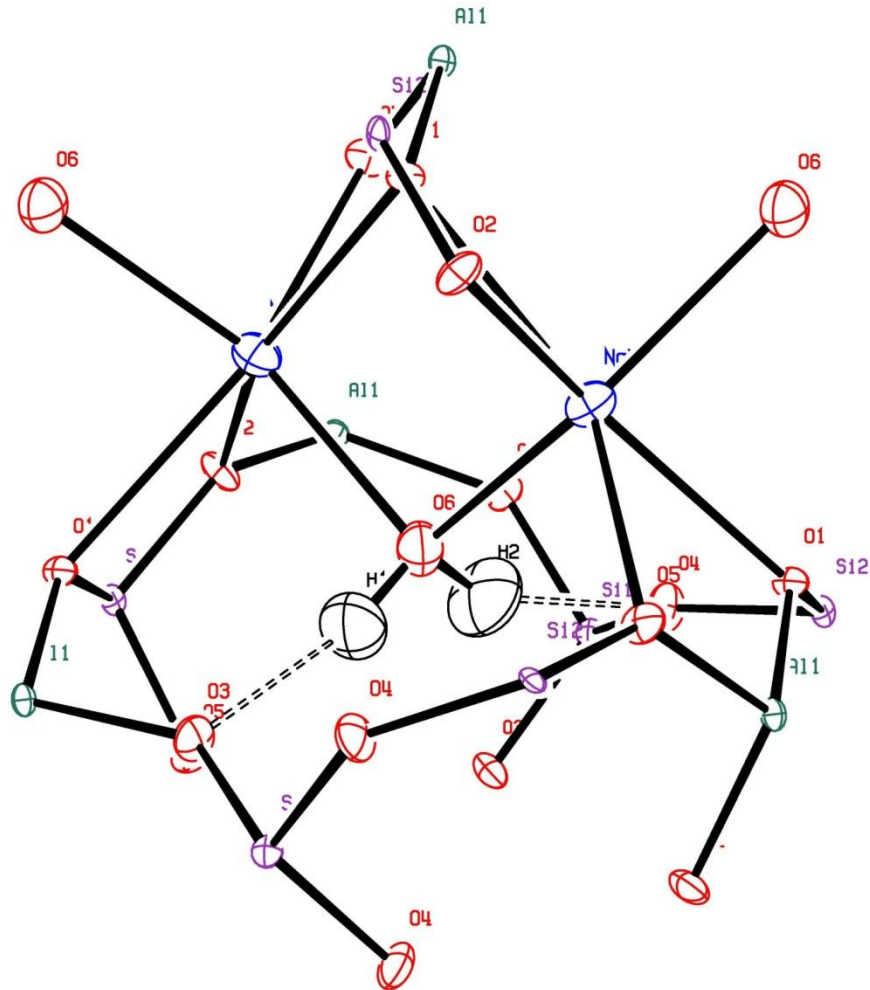

# Outline of single crystal structure analysis

- Collect some initial data to determine the unit cell and the space group.
  - Auto-index peaks to determine unit cell and orientation
  - Examine symmetry of intensities and systematic absences
- Measure a full data set of observed intensities.
- Reduce the raw integrated intensities,  $I_{hkl}$ , to structure factor amplitudes,  $|F_{\text{obs}}|^2$ .
- Solve the structure.
- Refine the structure.



# Data reduction

Data reduction: convert raw integrated intensities,  $I_{hkl}$ , into relative structure factor amplitudes,  $|F_{hkl}|^2$ .

$$I_{hkl} = k \tau(\lambda) \phi(\lambda) \varepsilon(\lambda) A(\lambda) (V_s/V_c) (|F_{hkl}|^2/V_c) \lambda^4/\sin^2 \Theta$$

$$I_{hkl} = k \tau(\lambda) \phi(\lambda) \varepsilon(\lambda) A(\lambda) N_c (|F_{hkl}|^2/V_c) \lambda^4/\sin^2 \Theta$$

$k$  = scale factor

$\phi(\lambda)$  = incident flux spectrum, obtained by measuring the incoherent scattering from a vanadium sample

$\varepsilon(\lambda)$  = detector efficiency calculated as a function of wavelength  $\lambda$

$A(\lambda)$  = sample absorption; includes the wavelength dependence of the linear absorption coefficients

$V_s$  = sample volume

$V_c$  = unit cell volume

$N_c$  = number of unit cells in the sample

# Fourier transforms

$$\rho(xyz) = \frac{1}{V} \sum_{hkl} F_{hkl} e^{-2\pi i(hx+ky+lz)}$$

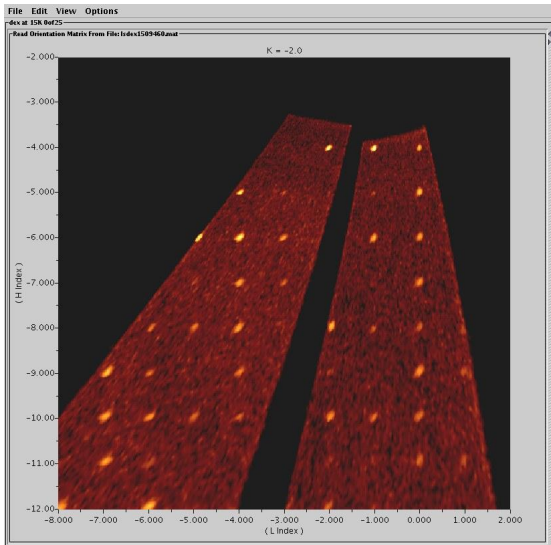

$$I_{hkl} \propto |F_{hkl}|^2$$

$$F_{hkl} = |F_{hkl}| e^{i\phi}$$

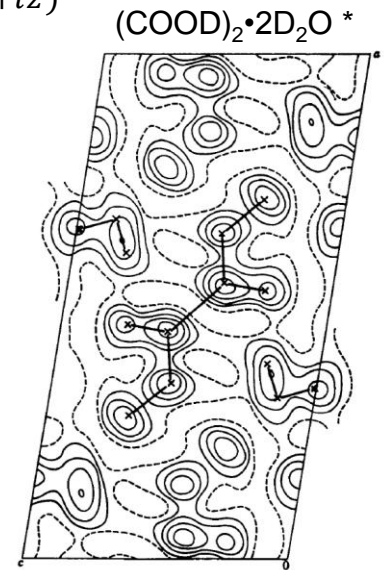

Fig.3. Neutron scattering density projection along the  $b$  axis. The contours are at intervals of  $4 \times 10^{-13} \text{ cm.}\text{\AA}^{-2}$ , and broken lines are zero contours.

$$F_{hkl} = \int_{\text{cell}} \rho_{xyz} e^{2\pi i(\mathbf{s} \cdot \mathbf{r})} d\mathbf{v} = \sum_j b_j e^{2\pi i(hx_j + ky_j + lz_j)}$$

Sum over  $j$  atoms in the unit cell.

Neutron scattering length of the  $j^{\text{th}}$  atom,

\* Iwasaki, Iwasaki and Saito, *Acta Cryst.* **23**, 1967, 64.

# The phase problem

Measured intensity

$$I_{hkl} \propto |F_{hkl}|^2$$

Electron (X-ray) or nuclear (neutron) density at point  $x,y,z$  in the unit cell

$$\rho(xyz) = \frac{1}{V} \sum_{hkl} F_{hkl} e^{-2\pi i(hx+ky+lz)}$$

Phase angle

$$F_{hkl} = |F_{hkl}| e^{i\phi} = |F_{hkl}| \cos \phi + i |F_{hkl}| \sin \phi = A + iB$$
$$\phi = \tan^{-1} \frac{B}{A}$$
$$F_{hkl} = \int_{cell} \rho_{xyz} e^{2\pi i(\mathbf{s} \cdot \mathbf{r})} d\mathbf{v} = \sum_j b_j e^{2\pi i(hx_j+ky_j+lz_j)}$$

Sum over  $j$  atoms in the unit cell

Neutron scattering length or X-ray form factor for  $j^{\text{th}}$  atom

# Solutions to the phase problem

- Patterson synthesis using the  $|F_{\text{obs}}|^2$  values as Fourier coefficients
  - Map of inter-atom vectors
  - Also called the heavy atom method
- Direct methods
  - Based on probability that the phase of a third peak is equal to the sum of the phases of two other related peaks.
  - J. Karle and H. Hauptman received the 1985 Nobel Prize in Chemistry
- Shake-and-bake
  - Alternate between modifying a starting model and phase refinement
- Charge flipping
  - Start out with random phases.
  - Peaks below a threshold in a Fourier map are flipped up.
  - Repeat until a solution is obtained
- MAD
  - Multiple-wavelength anomalous dispersion phasing
- Molecular replacement
  - Based on the existence of a previously solved structure with of a similar protein
  - Rotate the molecular to fit the two Patterson maps
  - Translate the molecule

# Structure Refinement

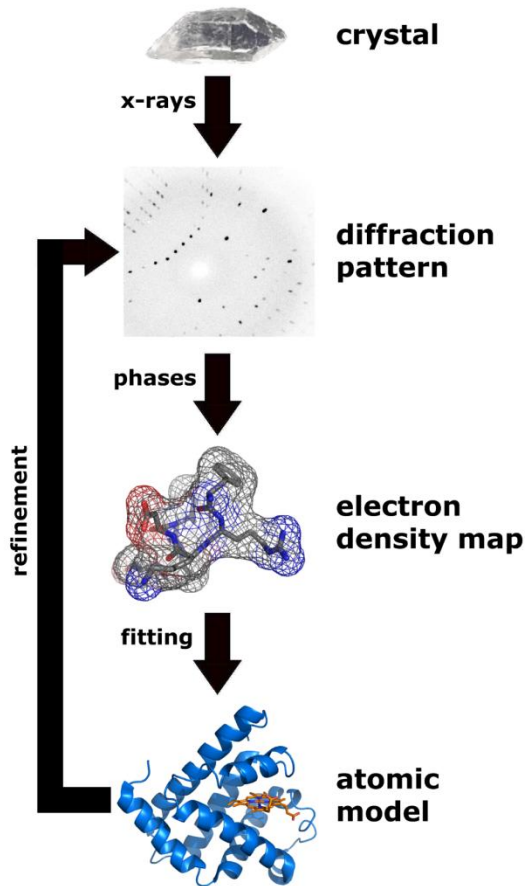

$$\chi^2 = \sum_{hkl} w(|F_0| - |F_c|)^2$$

$$F_{hkl} = \sum_i b_i \exp[2\pi i(hx_i + ky_i + lz_i)] \exp[-8\pi^2 U_i \sin^2 \theta / \lambda^2]$$

GSAS, SHELX, CRYSTALS, OLEX2, WinGX...

Nonlinear least squares programs. Vary atomic fractional coordinates  $x, y, z$  and temperature factors  $U$  (isotropic) or  $u_{ij}$  (anisotropic) to obtain best fit between observed and calculated structure factors.

# Neutron single crystal instruments in the US

- **SNAP** @ SNS: high pressure sample environment (<http://neutrons.ornl.gov/instruments/SNS/SNAP/>)
- **TOPAZ** @ SNS: small molecule to small protein, magnetism, future polarized neutron capabilities (<http://neutrons.ornl.gov/instruments/SNS/TOPAZ/>)
- **Four-Circle Diffractometer (HB-3A)** @ HFIR: small molecule, high precision, magnetism (<http://neutrons.ornl.gov/instruments/HFIR/HB3A/>)
- **MaNDi** (Macromolecular Neutron Diffractometer) @ SNS: neutron protein crystallography, commissioning in 2012 (<http://neutrons.ornl.gov/instruments/SNS/MaNDi/>)
- **IMAGINE** (Image-Plate Single-Crystal Diffractometer) @ HFIR: small molecule to macromolecule crystallography , commissioning in 2012 (<http://neutrons.ornl.gov/instruments/HFIR/imagine/>)
- **SCD** @ Lujan Center, Los Alamos: general purpose instrument, currently not available due to budget constraints (<http://lansce.lanl.gov/lujan/instruments/SCD/index.html>)
- **PCS** (Protein Crystallography Station) @ Lujan Center, Los Alamos: neutron protein crystallography (<http://lansce.lanl.gov/lujan/instruments/PCS/index.html>)

# Books and on-line tutorials

- George E. Bacon, *Neutron Diffraction*, 3<sup>rd</sup> ed., Clarendon Press, 1975.
- Colin G. Windsor, *Pulsed Neutron Scattering*, Taylor & Francis, 1981.
- Chick C. Wilson, *Single Crystal Neutron Diffraction From Molecular Crystals*, World Scientific, 2000.
  
- M. F. C. Ladd and R. A. Palmer, *Structure Determination by X-ray Crystallography, Third Edition*, Plenum Press, 1994.
- J. P. Glusker and K. N. Trueblood, *Crystal Structure Analysis: A Primer*, 2<sup>nd</sup> ed., Oxford University Press, 1985.
  
- Interactive Tutorial about Diffraction: [www.totalscattering.org/teaching/](http://www.totalscattering.org/teaching/)
- IPNS SCD tutorial by Paula Piccoli: [www.pns.anl.gov/instruments/scd/subscd/scd.shtml](http://www.pns.anl.gov/instruments/scd/subscd/scd.shtml)

